

A

A

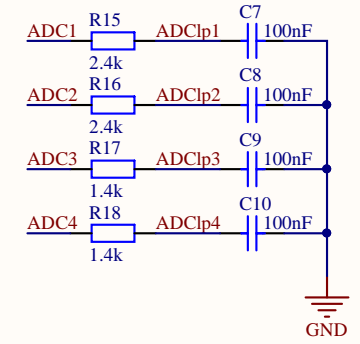
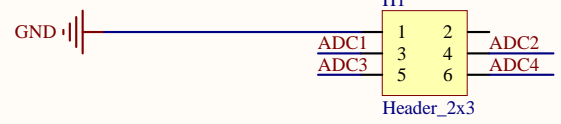
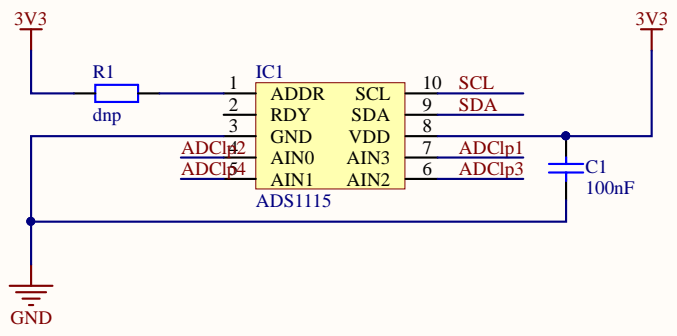

B

B

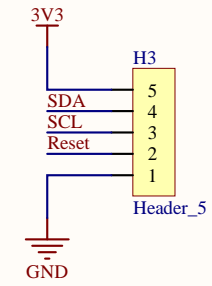
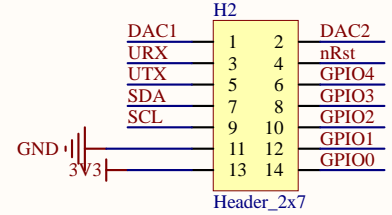
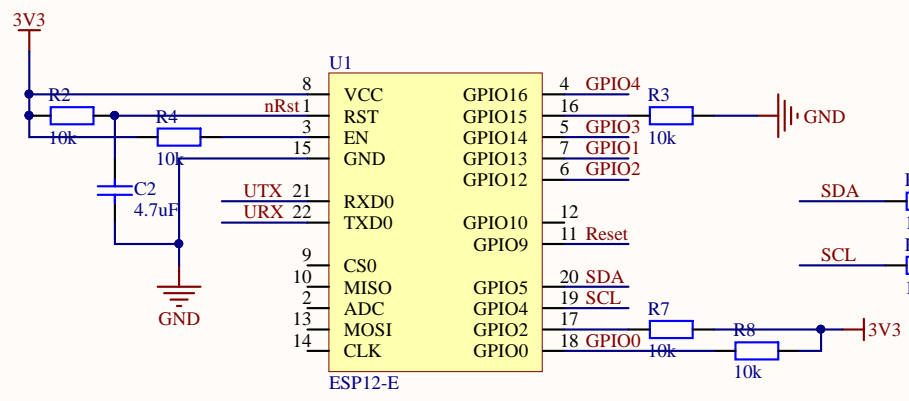

C

C

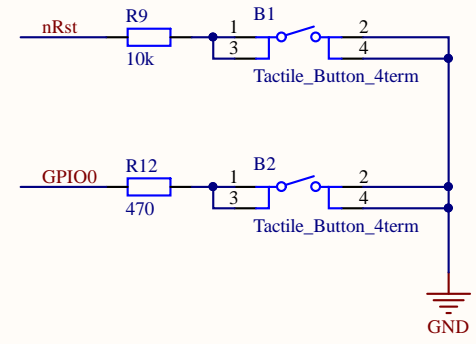
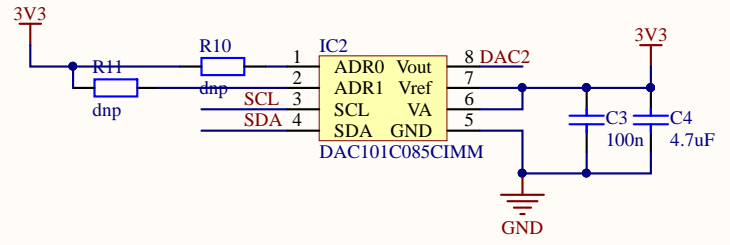

D

D

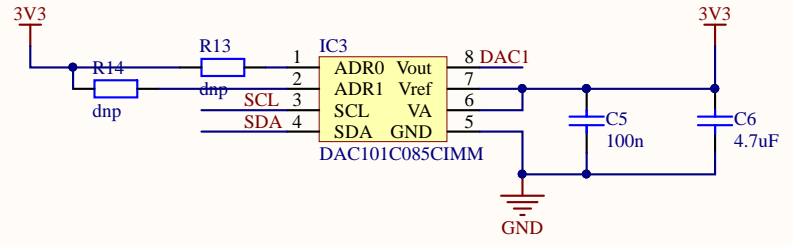

Title		
Size	Number	Revision
A		
Date:	08-Jul-17	Sheet of
File:	C:\Users\...\lupsense.SchDoc	Drawn By: